

# Installation and Operating Instructions

## Bulletin 802B Compact Limit Switch

**IMPORTANT: SAVE THESE INSTRUCTIONS FOR FUTURE USE.**  
 This publication does not include specifications, dimensions, and other installation considerations.  
 Refer to the product catalog pages for additional information.



**WARNING:** To avoid electrical shock and/or unintended operation of equipment, disconnect all power to the limit switch and the controlled equipment before proceeding with any repair or adjustment of the limit switch.

### Overview

Limit Switches are used in electrical control systems to sense position. They are actuated by the predetermined motion of a cam, machine component, or piece part. This mechanical motion is then converted to an electrical signal through the actuation of a set of contacts. These signals can be used in the control circuits of solenoids, control relays, and motor starters to control the operation of conveyors, hoists, elevators, machine tools, etc. They are not to be used to directly control a motor.

### General Data

- Enclosure Rating: NEMA 1,3,4,6,12,13 and IP67
- Mechanical Life: Approx. 10,000,000 operations ①
- Electrical Life: Approx. 200,000 operations (3A 250V AC, resistive load) ①
- Operating Speed
  - Top Push: 0.1mm to 0.5m per second
  - Side Rotary: 1mm to 1m per second
- Operating Frequency:
  - Mechanical: 120 operations/minute
  - Electrical: 30 operations/minute
- Operating Temperature:  $-10^{\circ}\text{C}$  to  $70^{\circ}\text{C}$  ( $14^{\circ}\text{F}$  to  $158^{\circ}\text{F}$ ) with no icing
- Short Circuit Protection: Quick blow fuse suitable for rated current is recommended.
- ① Life expectancy has been calculated at an operating temperature of  $5^{\circ}\text{C}$  to  $35^{\circ}\text{C}$  ( $41^{\circ}\text{F}$  to  $95^{\circ}\text{F}$ ) and an operating humidity of 40% to 70%.

the bolt heads. The use of M5 Cap Screws, (Hex head), and washers is recommended. Mounting bolts should be torqued to a value between 4.90 and 5.88 Nm. These units have been designed to enable gang mounting. In the case of ganged mounting, the installer should fit the convex part of the gang mount guide into the concave guide of the adjacent switch. A maximum of six switches may be ganged. Special units that have been designed for panel mounting will be provided with a threaded head. These switches will also have washers and a mounting nut included with the switch.

Hardware	Torque
Head mounting screw	0.78 to 0.88 N · m
Side rotary shaft bolt	4.90 to 5.88 N · m
Unit mounting screw	4.90 to 5.88 N · m

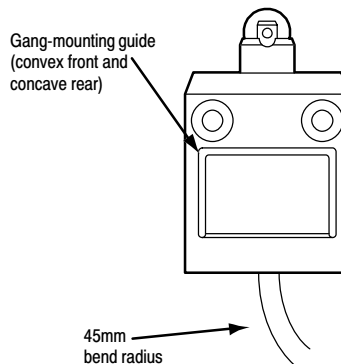

### Wiring

Pre-Leaded Models			
COM	NO	NC	G
Black	Blue	Brown	Green/Yellow
AC QD Pin-out:		DC QD Pin-out:	
Pin 1 = Common		Pin 1 = N/O	
Pin 2 = N/O		Pin 2 = Common	
Pin 3 = N/C		Pin 3 = Grnd.	
Pin 4 = Grnd.		Pin 4 = N/C	Male Receptacle

### Mounting

Units should be mounted using the mounting holes provided. These mounting holes are counter boarded to help contain

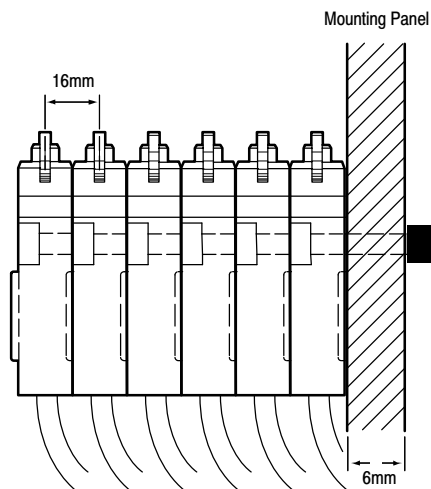

## Actuator Consideration

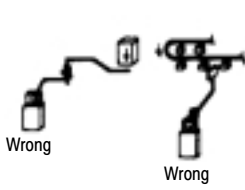

Limit switches are designed for proper performance with the actuators with which they are supplied. Supplementary actuators should not be used unless the limit switches are specifically designed for them.

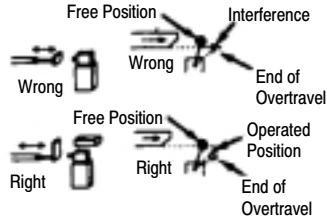

Operating mechanism for limit switches should be so designed that under any operating or emergency conditions the limit switch is not operated beyond its overtravel limit position. A limit switch should not be used as a mechanical stop.



For limit switches with lever actuators, the actuating force should be applied as nearly perpendicular to the lever as practical and perpendicular to the shaft axis about which the lever rotates.

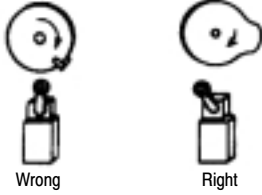

Where relatively fast motions are involved cam arrangements should be such that the actuator does not receive a severe impact. Cams should be designed such that the limit switch will be held operated long enough to operate relays, valves, etc.

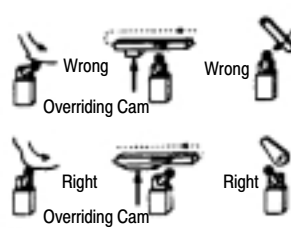

Cam or dog arrangements should be such that the actuator is not suddenly released to snap back freely.

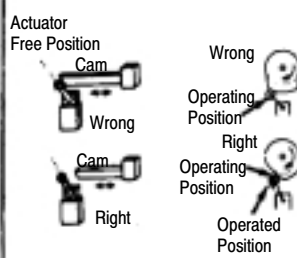

A limit switch actuator must be allowed to move far enough for positive operation of the contacts.

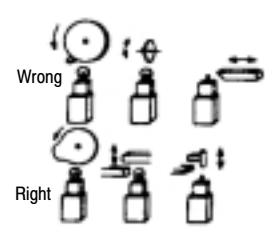

For limit switches with pushrod actuators the actuating force should be applied as nearly as possible in line with the pushrod axis.

## Location and Installation

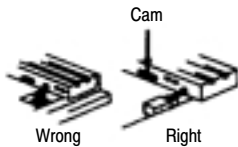

Limit switches should be mounted rigidly and in readily accessible locations with suitable clearances to permit easy service and replacement when necessary. Cover plates should face the maintenance access point.

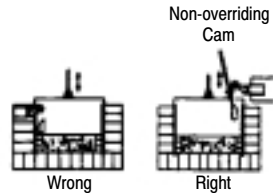

Limit switches should not be used in locations where temperature or atmosphere conditions are beyond those for which they have been specifically designed.

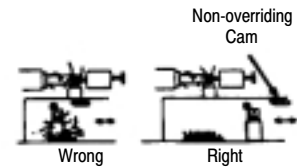

Limit switches should be placed in locations where machining chips do not accumulate under normal operating conditions.

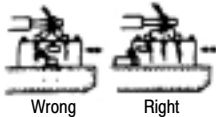

Limit switches should not be submerged in or splashed with oils, coolants or other liquids.

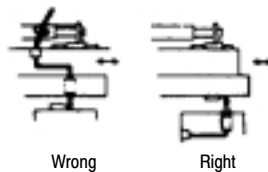

The location of oiltight limit switches and the method of connecting them should be such that condensation in the conduit cannot enter the switch enclosure.

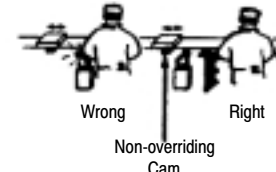

Limit switches should be mounted in locations which will prevent false operation by normal movements of operator or machine components.